

## SPICE thermal model

BUK769R6-80E

Symbol	Parameter	Conditions	Min	Typ	Max	Unit
$R_{th(j-mb)}$	thermal resistance from junction to mounting base		-	-	0.82	K/W

$C_{th1}$	1.128E-04 F
$C_{th2}$	8.153E-04 F
$C_{th3}$	6.066E-04 F
$C_{th4}$	2.369E-03 F
$C_{th5}$	6.973E-03 F
$C_{th6}$	1.600E-02 F
$C_{th7}$	5.627E-01 F
$C_{th8}$	5.931E+01 F
$R_{th1}$	7.791E-04 $\Omega$
$R_{th2}$	1.532E-03 $\Omega$
$R_{th3}$	1.801E-02 $\Omega$
$R_{th4}$	4.374E-02 $\Omega$
$R_{th5}$	1.604E-01 $\Omega$
$R_{th6}$	5.174E-01 $\Omega$
$R_{th7}$	9.637E-02 $\Omega$
$R_{th8}$	3.222E-03 $\Omega$

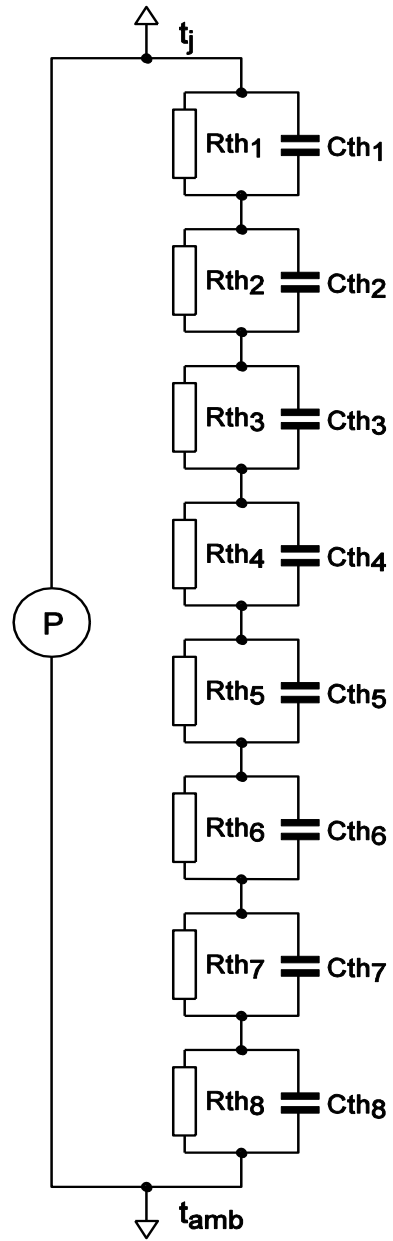

Part: BUK769R6-80E  
 Date: 11/4/2013  
 Model Rth 0.84 K/W